

Nanoscale to Millimeter Scale Milling with a Focused Ion Beam Instrument

Paul Tesch, Noel Smith, Noel Martin, Doug Kinion
Oregon Physics LLC

Introduction

- Focused ion beam instruments based on inductively coupled plasma ion sources have mill rates that exceed traditional liquid metal ion source FIBs at the microscale and macroscale.
- ICP based FIBs can be extended to the nanoscale by utilizing a focusing column that can demagnify the source by a factor of 200.
- A three lens electrostatic focusing column with a ICP ion source has been built and tested.
- The high angular intensity of the ICP ion source allows the three lens column to produce optimized nanoscale and microscale probes.

Inductively Coupled Plasma Ion Sources

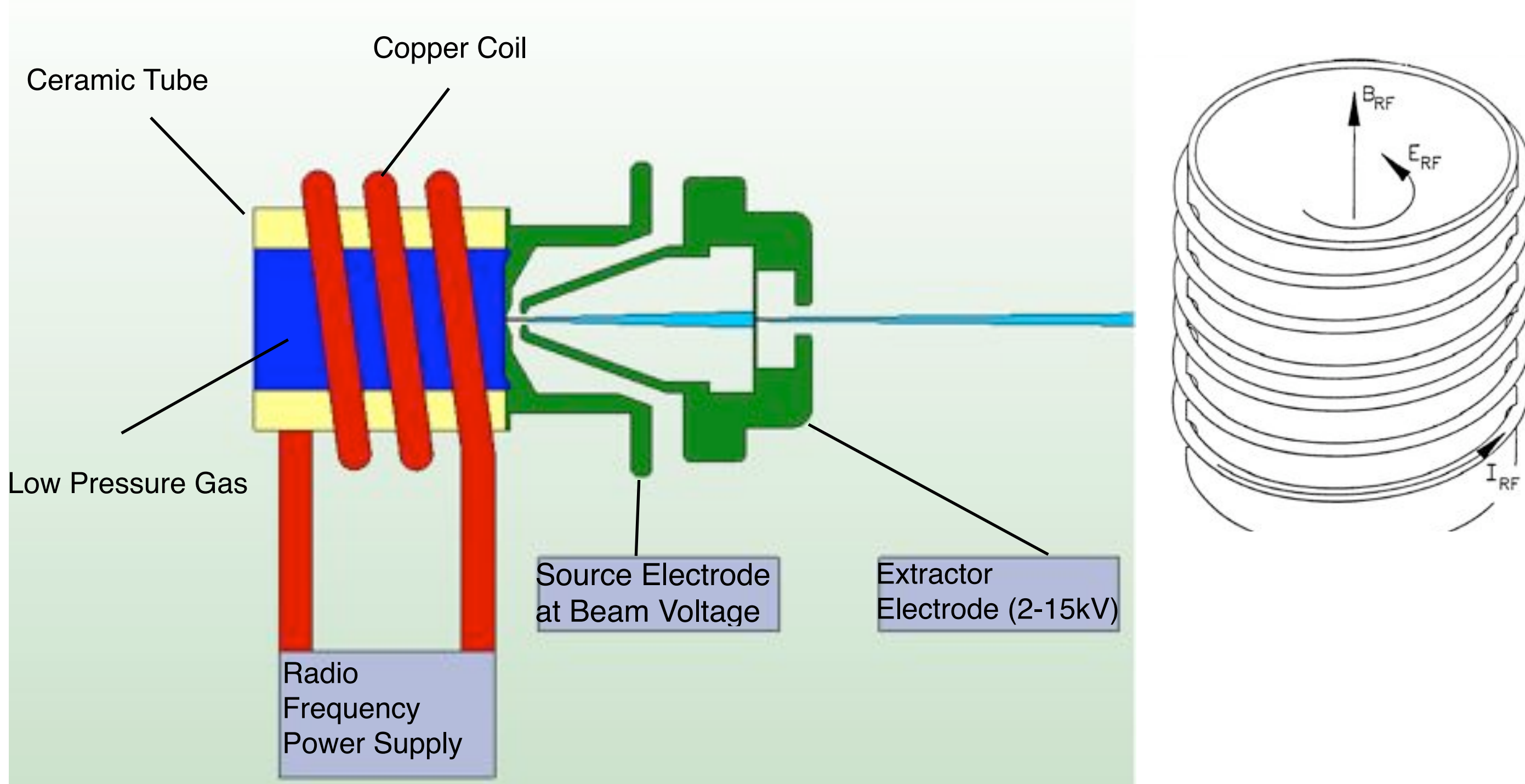

- Radio frequency current in the coil generates a time varying axial magnetic field.
- The time varying magnetic field produces an azimuthal electric field in the plasma through Faraday's law of induction.
- Radio frequency fields accelerate the electrons but not the ions resulting in low ion thermal energy.
- Efficient coupling into the plasma electrons results in high plasma density.
- Extracted ion beams have very high brightness due to the high plasma density and low ion thermal energy.
- Source operates with most gas species and has been tested with Helium, Oxygen, Xenon, and Argon.
- Low axial energy spread gives good performance in chromatic aberration limited applications.
- ICP plasma sources bridge the performance gap between plasma ion sources such as the Duoplasmatron and the LMIS.

Comparison with LMIS

- The LMIS has a nanoscale virtual source size but low angular intensity.
- ICP plasma source has microscale virtual source size and very high angular intensity.

LMIS with nanoscale emission area

ICP plasma source with 170 micron emission diameter

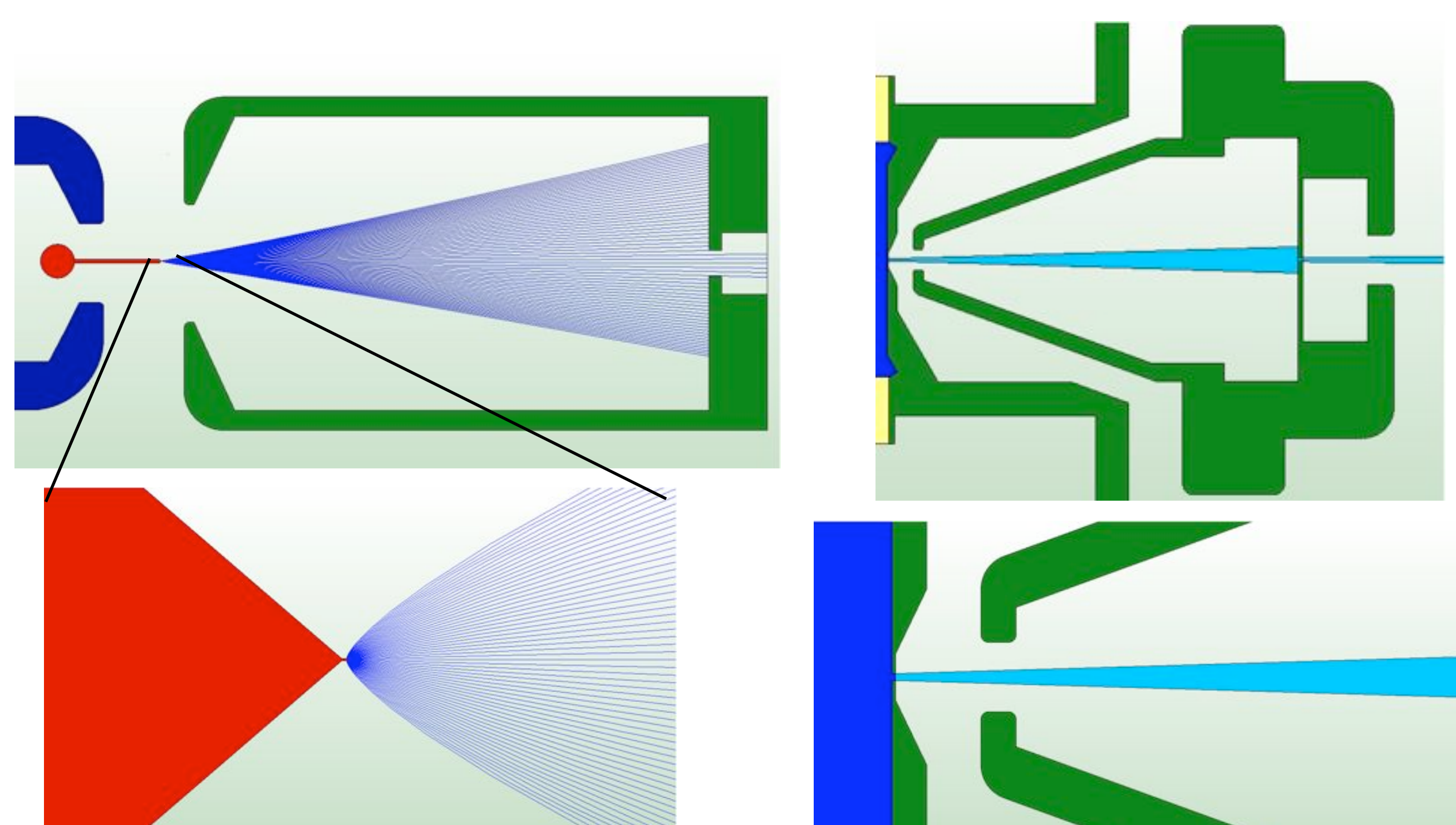

Source parameters for Gallium LMIS, Xenon ICP, and Argon Duoplasmatron sources

Source type	Virtual Source Size (microns)	Angular Intensity (mA/str)	Energy Spread (eV)
ICP(Xenon)	13	18	4 to 6
LMIS (Ga)	0.05	0.02	5
Duoplasmatron (Oxygen)	50	10	15

ICP Source FIB Column Performance

- ICP sources require three electrostatic lenses to demagnify the source and produce optimized nanoscale probes.

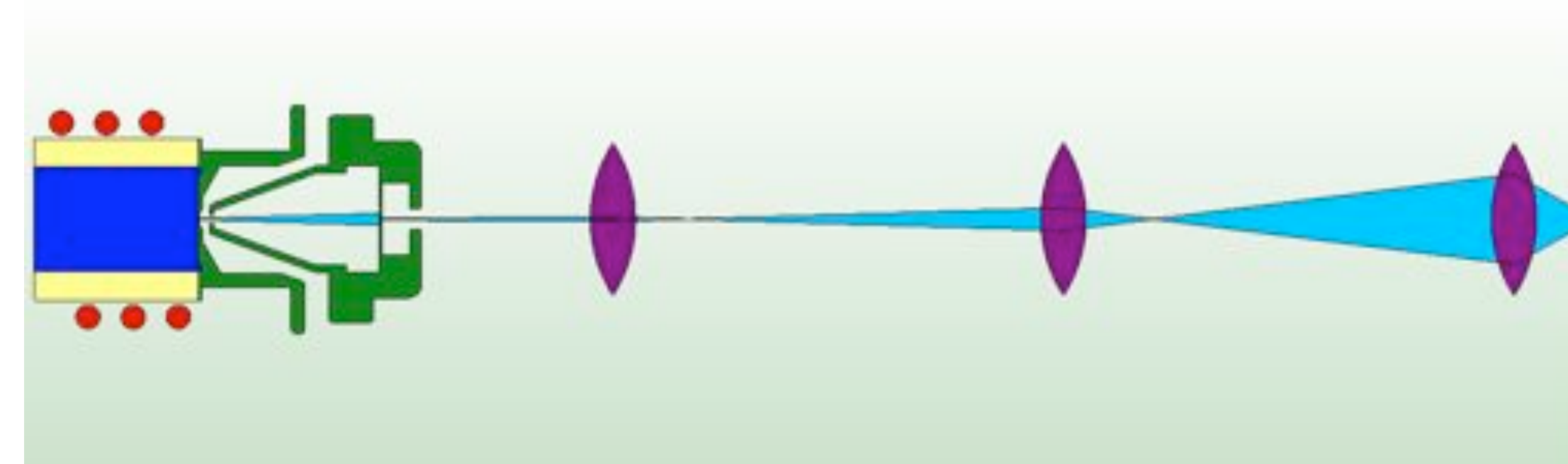

FIB Column Performance: Probe Size vs Current

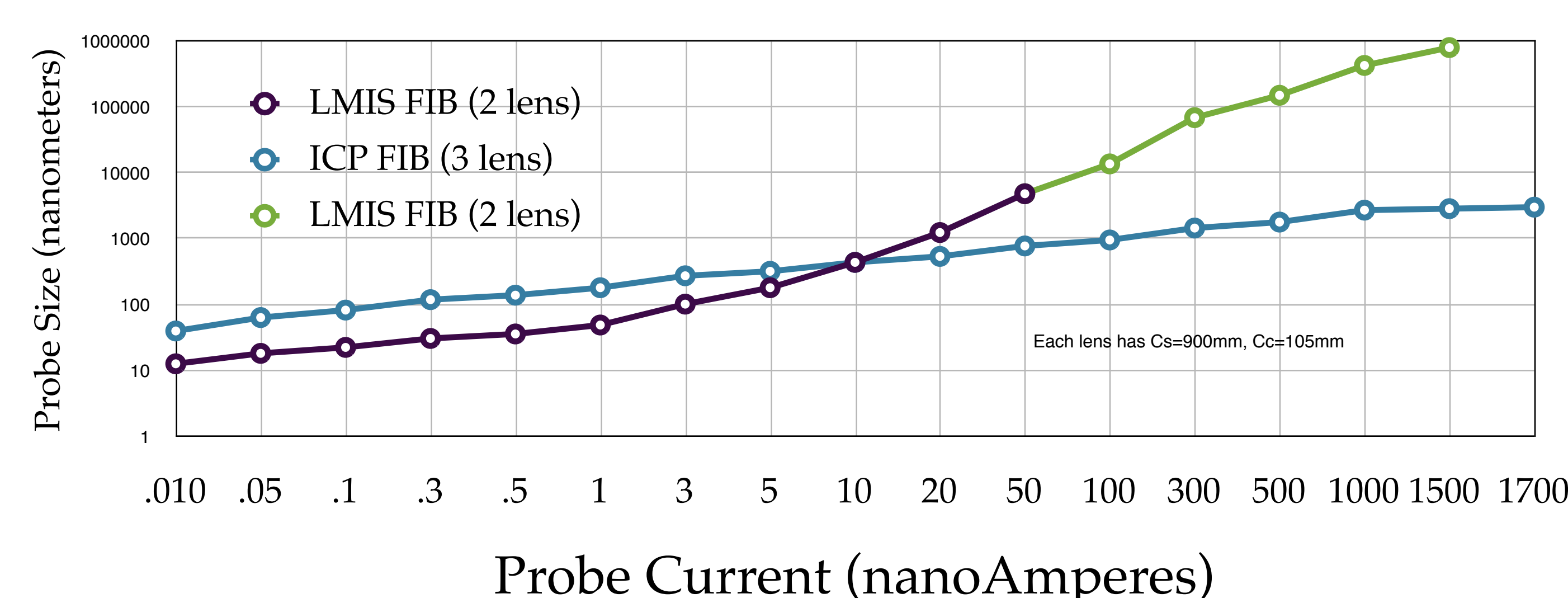

FIB Column Performance: Probe Brightness vs Current

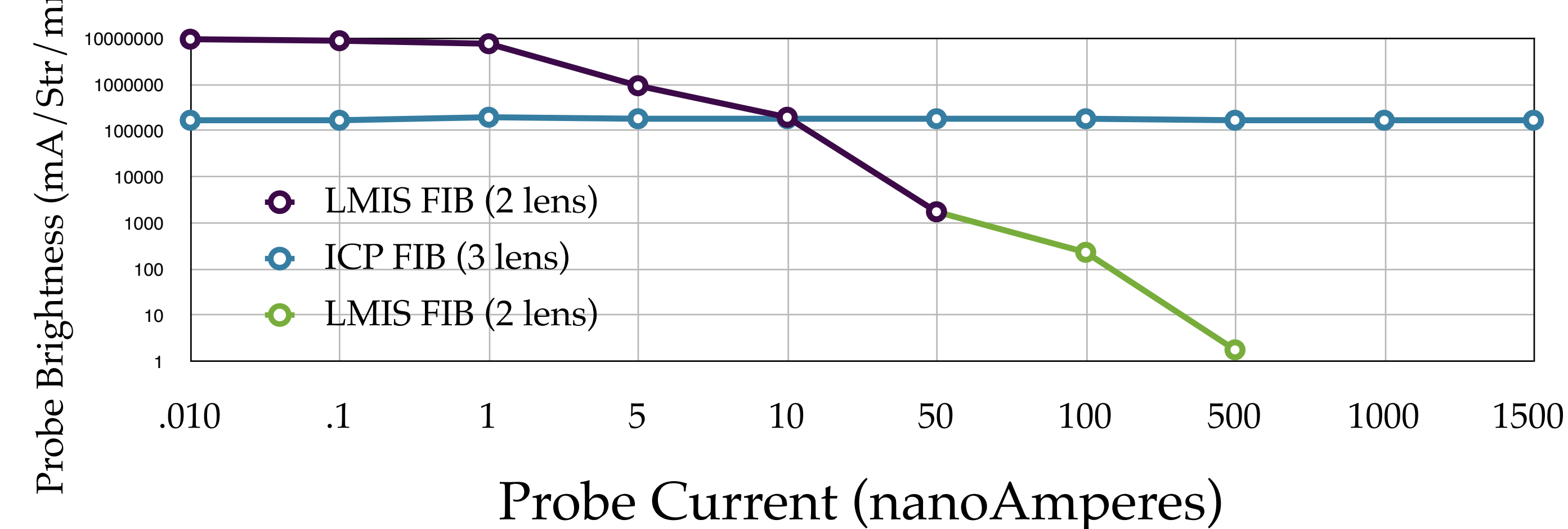

Conclusions

- An ICP ion source with a three lens electrostatic column can produce microscale and nanoscale probes without a loss of probe brightness from spherical aberrations.
- This instrument can produce high current ion probes for microscale and macroscale milling applications that require large volume removal.

Applications

- Cross-sections of microscale and macroscale structures for 3-D metrology and analysis.

Cross-section of a 750µm diameter solder ball from a Ball Grid Array. Cross-section cut with ~1500nA beam current in 6 hours.

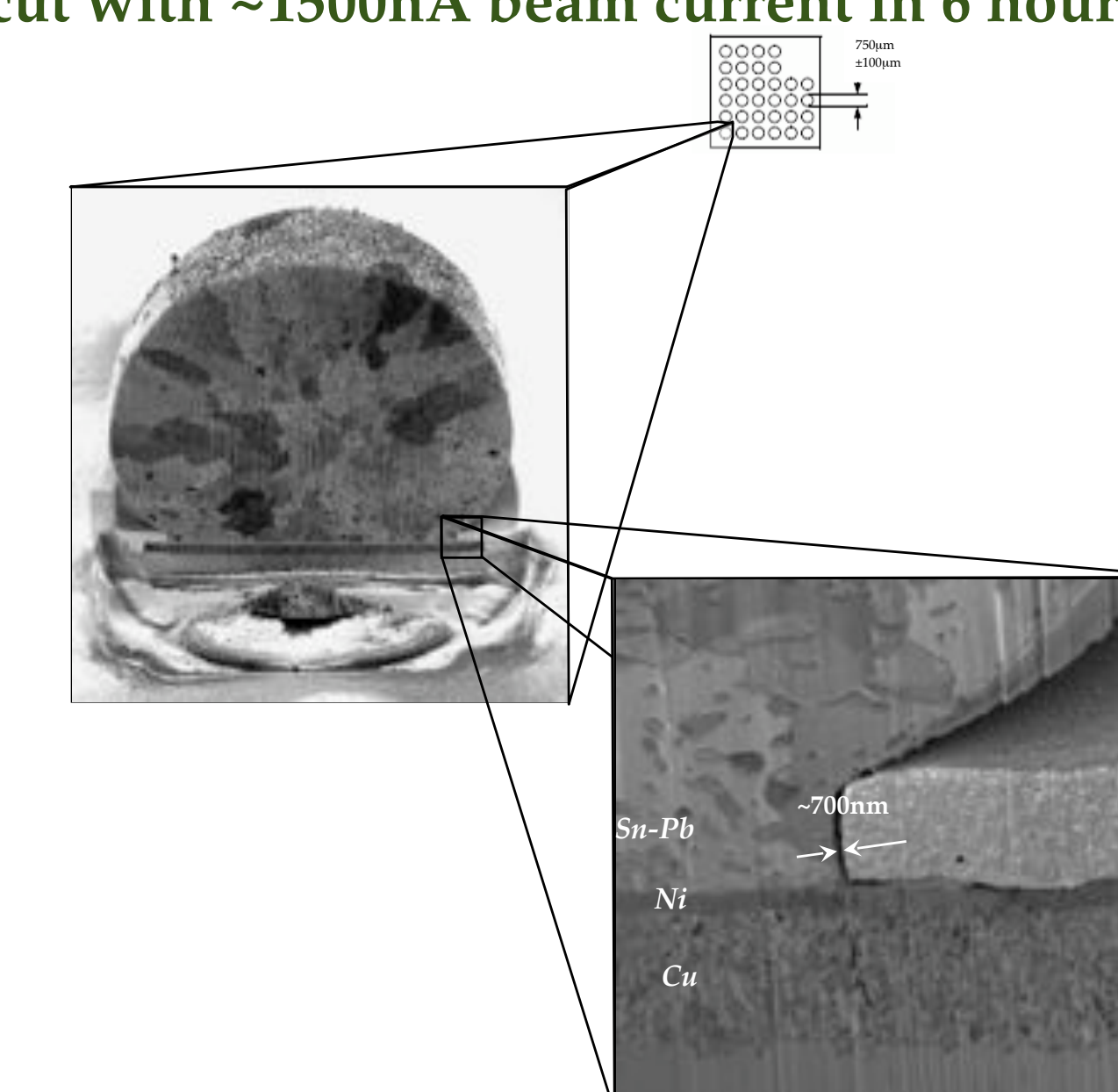

High power laser diode cross-sections milled with 100-300nA beam current

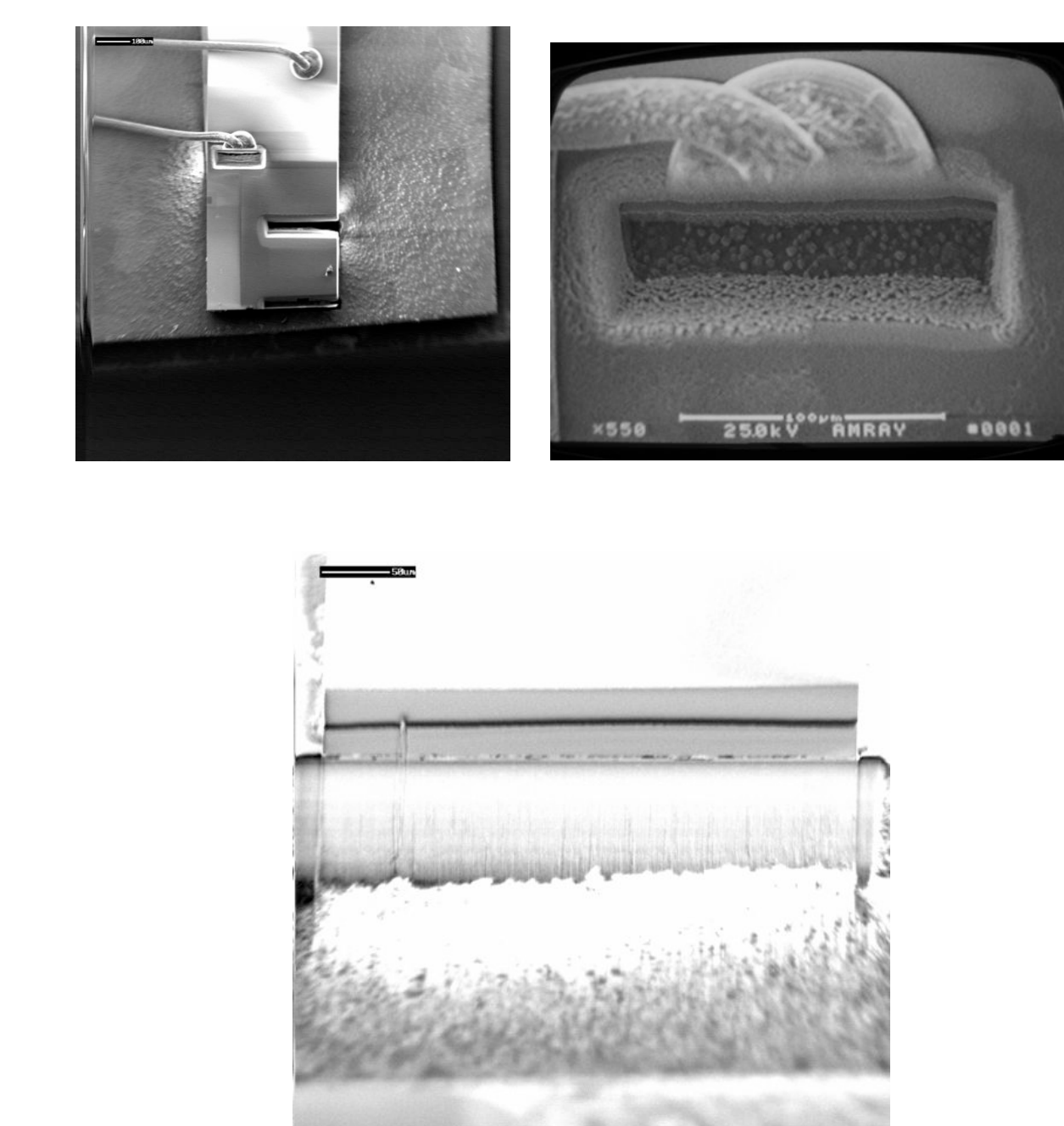

- High throughput FIB micromachining.

Micromachined holes in FIB aperture strip. Holes machined with Xenon beam currents of 150nA to 1500nA beam current.

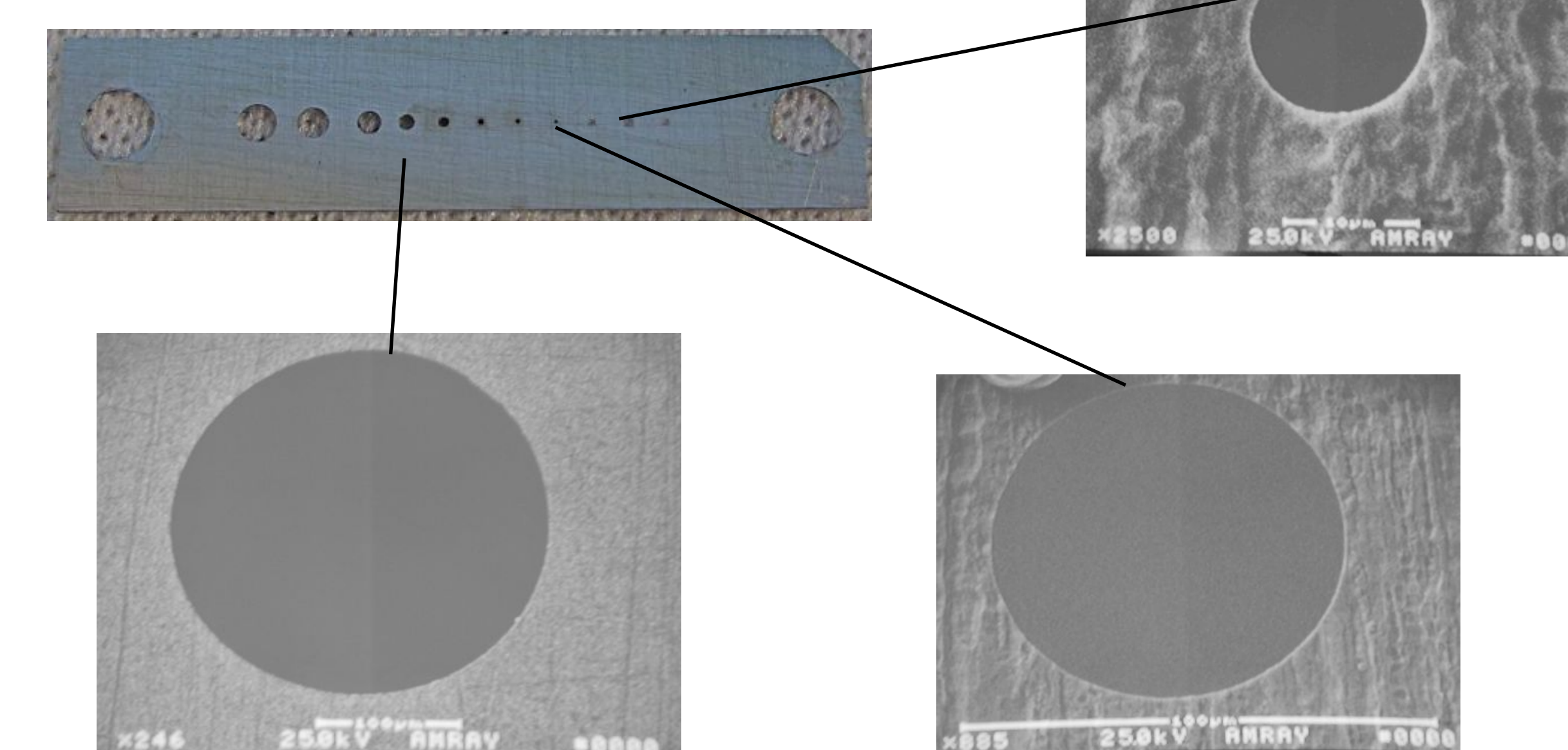

- Probes for microscale and nanoscale material analysis using Secondary Ion Mass Spectrometry (SIMS) and ion scattering techniques.

High resolution Oxygen probes for SIMS applications. Images taken with 300pA Oxygen beam.

